



WCN1-XX50XX-XXX

WCN2-XX50XX-XXX

WCN3-XX50XX-XXX

SERIES

0.50" SEVEN-SEGMENT NUMERIC LED DISPLAYS

### FEATURES

- High intensity and reliability.
- High quality and low cost.
- Choice of colors: Red/Orange/Green/Blue, etc
- Low power requirement.
- Ic compatible.
- Easy assembly.

### DESCRIPTION

The WCN1-XX50XX-XXX series are 0.50inch (12.6mm) height single digit displays. The WCN2-XX50XX-XXX series are 0.50inch (12.5mm) height dual digit displays. The WCN3-XX50XX-XXX series are triad digit displays. SH. Red displays have black face or gray face and milky segment or red segment. Orange displays have black face or gray face and milky segment or red segment. Bright Green displays have black face or gray face and milky segment or green segment.

### PACKAGE DIMENSIONS

#### A. WCN1-XX50XX-A1X/C1X

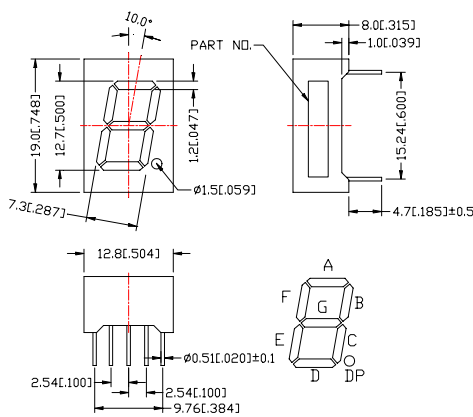

#### B. WCN2-XX50XX-A1X/C1X

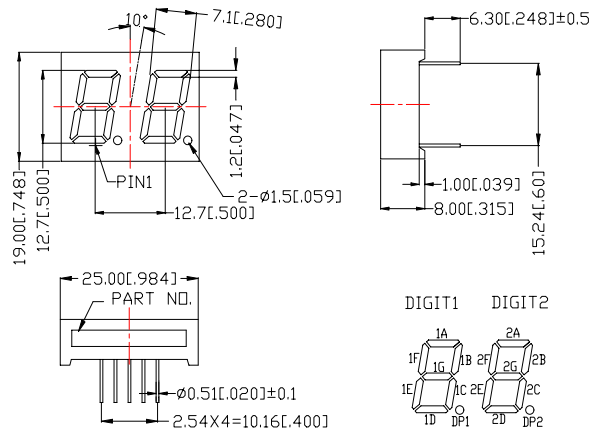

# PACKAGE DIMENSIONS

## C. WCN2-XX50XX-A2X/C2X

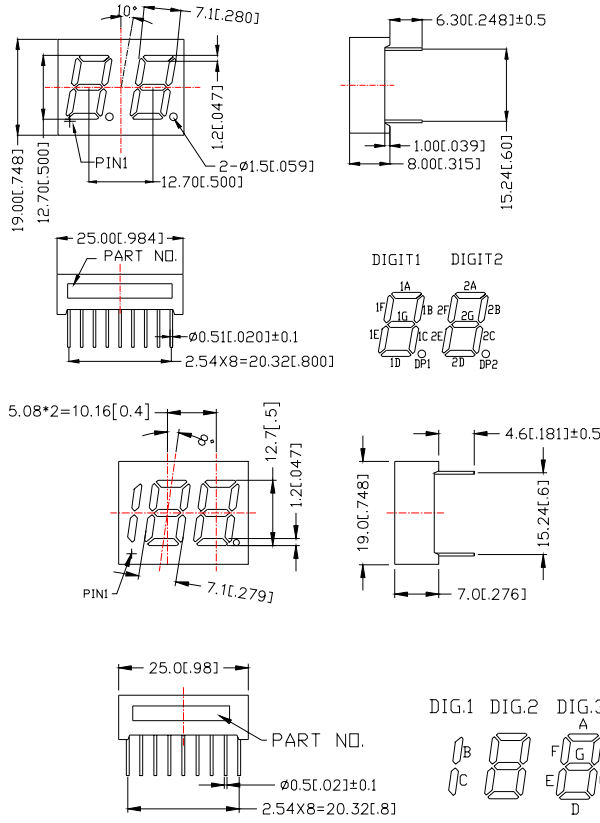

## D. WCN3-XX50XX-A1X/C1X

NOTES: All dimensions are in millimeters (inches) tolerance are  $\pm 0.25\text{mm}(0.010)$  unless otherwise noted.

## INTERNAL CIRCUIT DIAGRAM

### A. WCN1-XX50XX-A1X

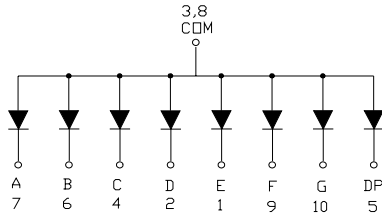

### B. WCN1-XX50XX-C1X

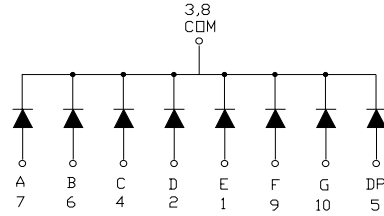

### C. WCN2-XX50XX-A1X

### D. WCN2-XX50XX-C1X

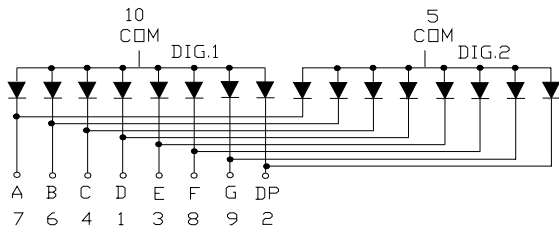

**E. WCN2-XX50XX-A2X**

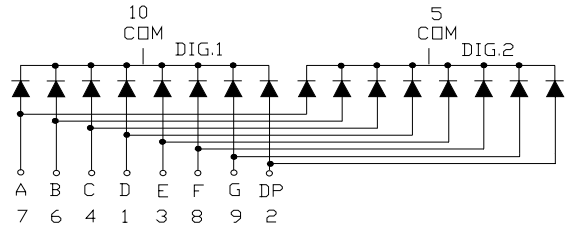

**F. WCN2-XX50XX-C2X**

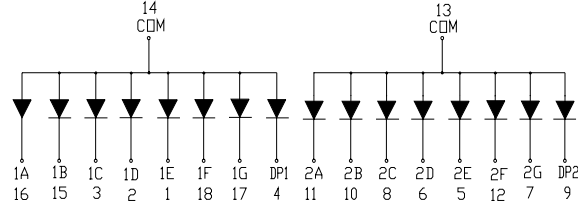

**G. WCN3-XX50XX-A1X**

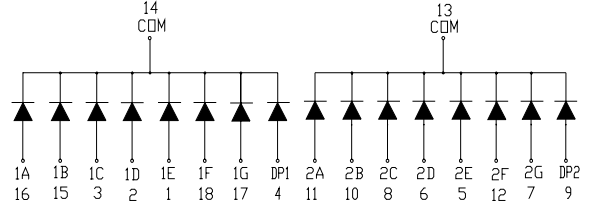

**H. WCN3-XX50XX-C1X**

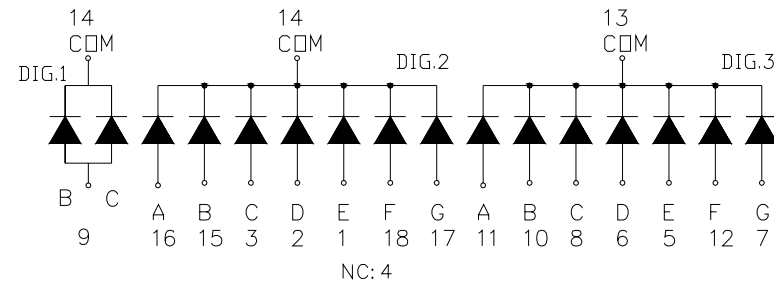
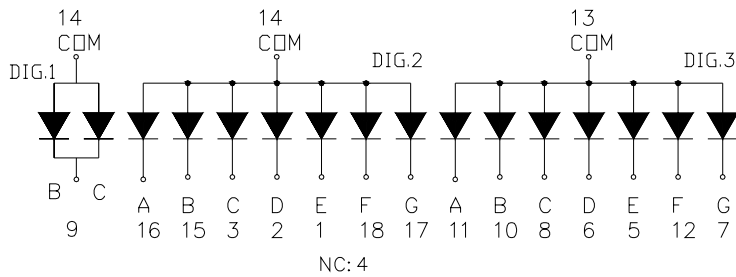

**ABSOLUTE MAXIMUM RATINGS AT  $T_a=25^\circ\text{C}$**

PARAMETER	SH.RED	ORANGE	BRIGHT GREEN	UNIT
Power Dissipation Per Segment	50	65	65	mW
Peak Forward Current Per Segment (1/10 duty cycle 0.1ms pulse width)	100	100	100	mA

Continuous Forward Current Per Segment Derating Linear From 25°C Per Segment	25 0.30	25 0.20	25 0.33	mA mA/°C
Reverse Voltage Per Segment	5	5	5	V
Operating Temperature Range	-35°C to + 85°C			
Storage Temperature Range	-35°C to + 85°C			
Solder Temperature 1/16 inch below seating plane for 3 seconds at 260°C				

2-32

### ELECTRICAL/OPTICAL CHARACTERISTICS AT T<sub>a</sub>=25°C

WCN1-0050SR-A11/C11;WCN2-0050SR-A11/C11/A21/C21;WCN3-0050SR-A11/C11

PARAMETER	SYMBOL	MIN.	TYP.	MAX.	UNIT	TEST CONDITION
Luminous Intensity Per Segment	I <sub>V</sub>	3.0	4.5	—	mcd	I <sub>F</sub> =10mA
Dominant Wavelength	λ <sub>D</sub>	—	643	—	nm	I <sub>F</sub> =20mA
Peak Emission Wavelength	λ <sub>P</sub>	—	660	—	nm	I <sub>F</sub> =20mA
Spectral Line Half-Width	Δλ	—	20	—	nm	I <sub>F</sub> =20mA
Forward Voltage Per Segment	V <sub>F</sub>	—	1.8	2.0	V	I <sub>F</sub> =20mA
Reverse Current Per Segment	I <sub>R</sub>	—	—	100	μA	V <sub>R</sub> =5V
Luminous Intensity Matching Ratio (Segment To Segment)	I <sub>V-m</sub>			2:1		I <sub>F</sub> =10mA

### ELECTRICAL/OPTICAL CHARACTERISTICS AT T<sub>a</sub>=25°C

WCN1-0050HO-A11/C11;WCN2-0050HO-A11/C11/A21/C21;WCN3-0050HO-A11/C11

PARAMETER	SYMBOL	MIN.	TYP.	MAX.	UNIT	TEST CONDITION
Luminous Intensity Per Segment	I <sub>V</sub>	1.25	2.5	—	mcd	I <sub>F</sub> =10mA
Dominant Wavelength	λ <sub>D</sub>	—	622	—	nm	I <sub>F</sub> =20mA
Peak Emission Wavelength	λ <sub>P</sub>	—	632	—	nm	I <sub>F</sub> =20mA
Spectral Line Half-Width	Δλ	—	35	—	nm	I <sub>F</sub> =20mA
Forward Voltage Per Segment	V <sub>F</sub>	—	2.05	2.6	V	I <sub>F</sub> =20mA
Reverse Current Per Segment	I <sub>R</sub>	—	—	100	μA	V <sub>R</sub> =5V

Luminous Intensity Matching Ratio (Segment To Segment)	$I_{V-m}$			2:1		$I_F=10mA$
---	-----------	--	--	-----	--	------------

**WCN1-0050GU-A11/C11;WCN2-0050GU-A11/C11/A21/C21;WCN3-0050GU-A11/C11**

PARAMETER	SYMBOL	MIN.	TYP.	MAX.	UNIT	TEST CONDITION
Luminous Intensity Per Segment	$I_V$	1.5	3.5	—	mcd	$I_F=10mA$
Dominant Wavelength	$\lambda_D$	—	573	—	nm	$I_F=20mA$
Peak Emission Wavelength	$\lambda_P$	—	568	—	nm	$I_F=20mA$
Spectral Line Half-Width	$\Delta\lambda$	—	30	—	nm	$I_F=20mA$
Forward Voltage Per Segment	$V_F$	—	2.25	2.6	V	$I_F=20mA$
Reverse Current Per Segment	$I_R$	—	—	100	$\mu A$	$V_R=5V$
Luminous Intensity Matching Ratio (Segment To Segment)	$I_{V-m}$			2:1		$I_F=10mA$